

Horizon

BQ-470

EVA or PUR



i2i System
Connectable Product

The Horizon BQ-470 Fully Automated, 4-Clamp Perfect Binder features an interchangeable glue tank for both EVA and PUR adhesives.

Features

- Fully automated set-up through the intuitive icon based LCD touchscreen.
- Customer replaceable glue tank unit for both EVA hotmelt and PUR hotmelt adhesives to meet varying customer requirements.
- Simplified and accurate changeover to produce professionally finished books.
- Equipped with two large application rollers for strong, high-quality binds and a separate side glue tank for added flexibility.
- Space-saving design with front operation and front maintenance.
- Book-binding up to 65 mm (2.55") thickness.
- Easily operated by anyone in the bindery. Maximum cycle speed is 1,350 books per hour (EVA hotmelt glue).
- Ergonomic sliding windows provide easy, safe access and a clear view of operations.



Key Features

Color Touchscreen



The 10.4 inch large color touchscreen maximizes ease of operation. Trouble-shooting screen helps operator maintain smooth production.

Milling Lever

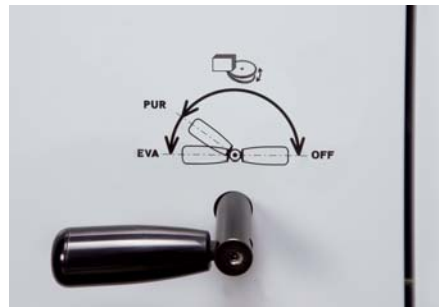

Three different milling styles can be selected: Milling Off, Milling for EVA or Milling for PUR.

Nipping Height Adjustment



A strong, rigid nipping mechanism ensures high quality binding. The nipping height is simple and easy to adjust.

Suction Cover Feed



The advanced rotary suction feed system insures faster production. A wide range of cover sheets can be handled without any marking.

Supersonic Double Feed Detect Sensor



The supersonic double feed detect sensor comes standard. Advanced detection with supersonic sensor ensures accurate double detection even with a solid black printed sheet.

Delivery Conveyor



The automated elevation conveyor can stack books up to 300 mm (11.8") high. The jogging table is attached to the conveyor for efficient operation.

Smoke Extractor

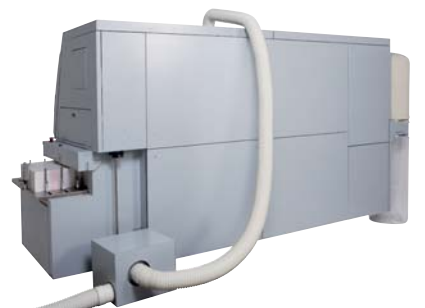

Extracts fumes of hotmelt glue for comfortable working conditions.



Automated set-ups ensure user-friendly and professional binding.

End-to-end Automated Set-up

- Carriage Clamp Width at book feeding section ①
- Guide Width at milling section ②
- Side Gluing Roller Width at glue tank unit ③
- Glue Length (Top-Bottom) at glue tank unit ③
- Wiper Opening for Glue Amount (First Application Roller/ Second Application Roller) at glue tank unit ③
- Spine Glue Thickness (Second Application Roller Height) at glue tank unit ③
- Nipping Width at nipping section ④
- Guide Width (Fore-edge) at cover registration section ⑤
- Cover Tail Edge Positioner at cover registration section ⑤
- Scoring Position (4 lines) at scoring section ⑥
- Guide Width at cover feeding section ⑦
- Guide Width at book delivery section ⑧

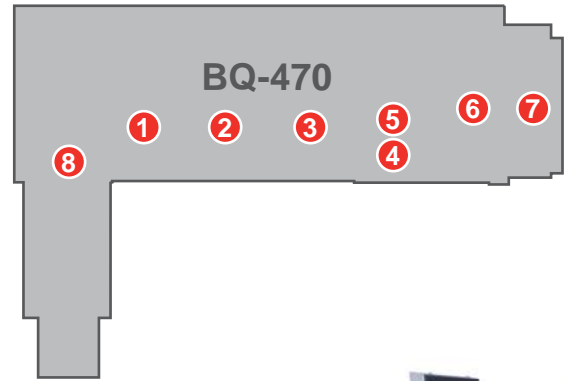

Book Feeding Section ①



Automated Point Carriage Clamp Width

A rigid clamping system holds the book block firmly in position during the milling and nipping process to produce a quality finished book. The safety beam ensures risk-free operation.

Milling Section ②



Automated Point Guide Width

Powerful servo motor driven milling and notching mechanism mills the spine of a book block or signature for optimum glue penetration and adherence. Milling depth can be adjusted from 0 to 4 mm (0" to 0.157").

Glue Tank Unit ③



Automated Point Spine Glue: Glue Length (Top-Bottom), Wiper Opening for Glue Amount (First Application Roller/Second Application Roller), Spine Glue Thickness (Second Application Roller Height), Side Glue: Side Gluing Roller Width

Dual application rollers and side gluing rollers ensure superior glue application to the spine for quality binding.

Nipping Section ④



Automated Point Nipping Width

A strong rigid nipping mechanism guarantees precise alignment of the cover to the book block. The nipping operating time and nipping delay time can be set up through the LCD touchscreen.

Cover Registration Section ⑤



Automated Point Guide Width (Fore-edge), Cover Tail Edge Positioner

After transport to the nipping section, the cover is registered precisely with the fore-edge guide and tail edge positioner.



ndly operation



Scoring Section

6

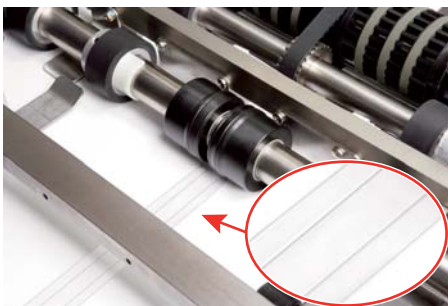

Automated Point Scoring Position (4 lines)

The scoring width and position are automatically set up through the LCD touchscreen. Scoring is performed on thick covers for professional binding with sharp, square spine corners.

Cover Feeding Section

7



Automated Point Guide Width

The high capacity cover feed station has a maximum pile height of 150 mm (5.9") for continuous binding operation. The cover feeder can handle a wide range of cover stocks from 81.4 to 302.4 gsm of normal paper or 104.7 to 348.9 gsm of coated paper.

Book Delivery Section

8

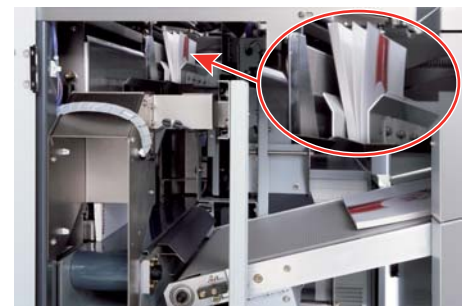

Automated Point Guide Width

The delivery section employs an elevation conveyor so that the bound books are gently received and transported to the stacker without damage to the book spine.

PUR Tank and EVA Tank

The BQ-470 incorporates the remarkable PUR binding mechanism and features an interchangeable glue tank, for both EVA and PUR adhesives.



PUR

MU-470PUR

Polyurethane reactive adhesive suitable for coated stock. Lay-flat binding can be performed.



EVA

MU-470EVA

Commonly used for all kinds of binding. The melted glue can be used repeatedly so there's no need to clean up the tank after operation.

Cleaning and Replacement of MU-470PUR



The application drums and back spinner lift and latch to provide easy access for cleaning of the tank.



Install the special drain for glue run-off. The PUR tank and drums are Teflon coated so that the remaining glue can be easily peeled off after cooling.



Sliding glue tank for easy replacement. Pull out the tank and remove it with the optional special lifter.

Strong, Environmentally Friendly PUR Solution

Polyurethane Reactive, also called PUR, is a polyurethane adhesive attracting attention in both binding strength and ecology.

Strong and Lay-Flat Binding

As the printing industry becomes more diverse, demands for binding with color prints are growing. EVA hotmelt glue has difficulty binding coated stock firmly and does not currently meet the requirements of Lay-Flat binding. However, the PUR hotmelt glue can provide adequate binding strength on both offset and digital prints for quality Lay-Flat spread binding.

The PUR hotmelt glue provides the best page spread compared to the traditional EVA hotmelt glue. High binding strength allows for the application of a small amount of glue so that well-spread books can be produced.



EVA

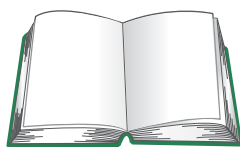

PUR



Durable against Temperature

The PUR hotmelt glue is durable against high and low temperatures. The temperature resistance for PUR hotmelt glue ranges from -20 to 120 degrees Celsius versus 0 to 60 degrees Celsius for EVA hotmelt glue. This allows the PUR bound book to be handled in almost any climate or location.

Ecology

PUR is an environmentally friendly adhesive and the PUR bound book can be recycled. At 120 degrees Celsius, the glue temperature for PUR is lower than that of EVA hotmelt glue during application and saves energy.

i2i System Option

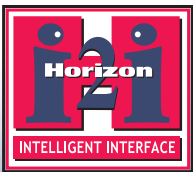

The Horizon i2i system can be integrated with pre-press and printing workflow to create a comprehensive automated CIP4 bindery with the prospect of jobs passing from the eye of the creator to the eye of the beholder in a single i2i Net>Work>Flow for ultimate flexibility and efficiency in the on-demand era.

The Last Frontier

Automating the Bindery...

Meet deadlines, enhance quality, make profit... think Horizon.



Horizon's i2i system can extract finishing data from JDF written upstream at pre-press or, where these are not available, data can be input at the i2i Control PC, to setup networked finishing equipment automatically. i2i offers ultimate efficiency of production and total bindery management by minimising downtime at makeready, reducing waste, increasing staff flexibility and allowing constant job information management.

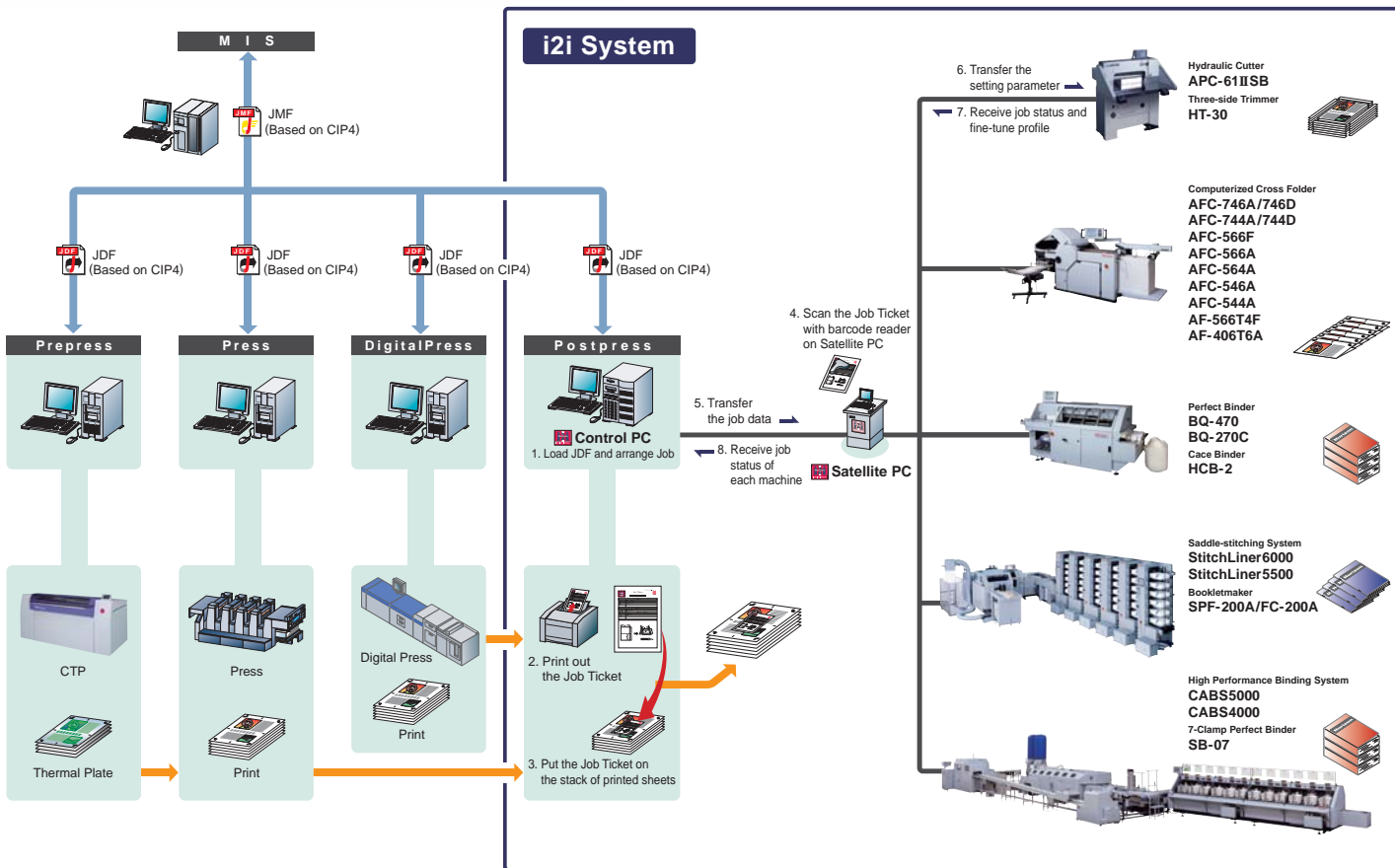

BQ-470 Major Specifications

Binding Mode	Binding with milling, Binding without milling and Padding	
Number of Clamps	4	
Book Block Size	Max. 320 x 320 mm (12.59" x 12.59")	
(Top-Bottom x Fore-edge)	Min. 145 x 105 mm (5.71" x 4.14")	
Book Thickness	0.3 to 65 mm (0.015" to 2.560") (The book thickness can be limited depending on the sheet weight, book size and milling depth.)	
Cover Size	Max. 320 x 660 mm (12.59" x 25.98") (Up to 350 mm or 13.77" forwards from the clamp face.) (Up to 310 mm or 12.20" backwards from the clamp face.)	
(Top-Bottom x Fore-edge)	Min. 135 x 225 mm (5.32" x 8.86") (Up to 115 mm or 4.53" forwards from the clamp face.) (Up to 110 mm or 4.34" backwards from the clamp face.)	
Cover Weight Range	Normal Paper 81.4 to 302.4 gsm Coated Paper 104.7 to 348.9 gsm	
Cover Pile Height	Max. 150 mm (5.9")	
Warm up Time	60 min.	
Glue Temperature	Spine Glue Tank	EVA : 150 to 210 °C (180 °C for HM-220) PUR : 110 to 140 °C
	Side Glue Tank	EVA : 150 to 210 °C (170 °C for HM-403)
Maximum Milling Depth	4 mm (0.157")	
Cycle Speed	EVA	Max. 1,350 cycles/hr.
	PUR	Max. 1,000 cycles/hr.
Voltage / Frequency	3-Phase 200 / 220 / 400 V, 50 / 60 Hz The external transformer is necessary for 220 V / 400 V.	
Rated Current	3-Phase 200 V	50 / 60 Hz 10.5 / 12.0 A (Max. 17.9 / 18.2 A)
	3-Phase 220 V	50 / 60 Hz 8.1 / 8.7 A (Max. 11.9 / 11.0 A)
	3-Phase 400 V	50 / 60 Hz 5.7 / 6.5 A (Max. 7.7 / 7.8 A)
Power Consumption	3-Phase 200 V	50 / 60 Hz 3.3 / 4.0 kW
	3-Phase 220 V	50 / 60 Hz 2.7 / 3.0 kW
	3-Phase 400 V	50 / 60 Hz 3.8 / 4.2 kW
Heat Output	13,030 kJ (3,120 kcal)	
Motors	3.7 kW x 1 / 750 W x 1 / 650 W x 1 / 400 W x 1 / 200 W x 3 / 100 W x 1 / 40 W x 1 / 25 W x 2 Delivery Conveyor : 40 W x 1 / 60 W x 1	
Heaters	650 W x 1 / EVA : 2.2 kW x 1 / PUR : 900 W x 1 / 80 W x 1	
Machine Dimensions	With delivery conveyor and milling blower duct : 3,620(W) x 2,240(D) x 2,000(H) mm (142.6" x 88.2" x 78.8")	
	Without delivery conveyor and milling blower duct : 3,220(W) x 1,090(D) x 2,000(H) mm (126.8" x 43.0" x 78.8")	
Machine Weight	Main Body : 1,970 kg (4,344 lbs.), Delivery Conveyor : 99 kg (219 lbs.), Transformer : 106 kg (234 lbs.)	

*The machine design and specifications are subject to change without any notice.

Machine Dimensions Unit : mm (inch)

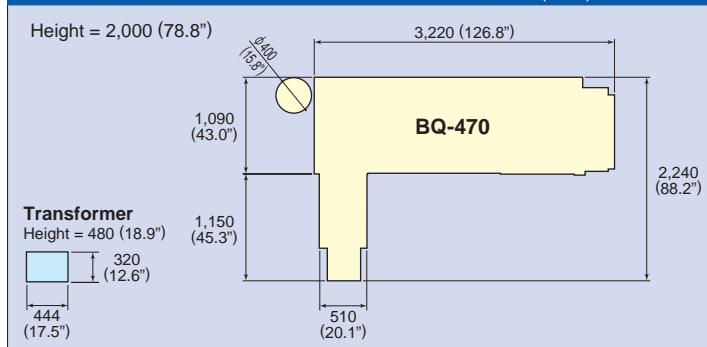

BQ-470 Options

■ SI-470 Book Thickness Measuring Device

The SI-470 is a book thickness measuring and input device for further operation efficiency.

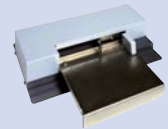

■ T-470 Weekly Timer

The T-470 weekly timer automatically switches power on at pre-set times for quick makeready. Time and day of the week can be set.



■ PM-470 Premelt Tank (18 liter)

The PM-470 is the premelt tank for EVA hotmelt glue.



■ L-470 Manual Simple Lifter F-470 Fork for Lifter

The L-470 is a hand lifter for easy and safe tank replacement.

The F-470 fork is a custom-fit attachment to the lifter that holds the glue tank firmly in position for easy and safe tank replacement.

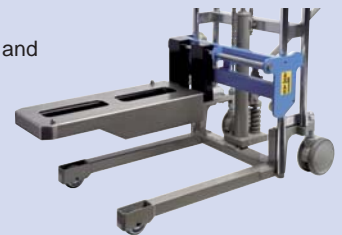

■ S-470 Stand for Melt Tank Unit

The S-470 stand is designed to receive and hold the glue tank unit after replacement.



■ M-470 Glue Melting Heater

The M-470 is a laboratory oven used to premelt the PUR hotmelt glue.



■ B-470 Teflon Coated Beaker

The B-470 Teflon coated beaker can be used to premelt the PUR hotmelt glue to refill the glue tank.



Distributed by



Standard Finishing Systems, 10 Connector Road, Andover, MA 01810 (877) 404-4460 www.standardfinishing.com

HORIZON INTERNATIONAL, INC.

510 Kuze Ooyabu-cho, Minami-ku, Kyoto, 601-8206, Japan Phone : +81-(0)75-934-6700, Fax : +81-(0)75-934-6708, www.horizon.co.jp